



 Elevatore idraulico ECO 1603 indicato per piccoli trattori, costruito con profili in acciaio stampato a "U" a contatto diretto, una catena centrale e un cilindro di sollevamento a doppio effetto.

 ECO 1603 hydraulic forklift suitable for small tractors, built with U-shaped steel profiles in direct contact, featuring a central chain and a double-acting lifting cylinder.

 Elévateur hydraulique ECO 1603, indiqué pour les petits tracteurs, construit avec des profilés en acier estampé en "U" à contact direct, une chaîne centrale et un vérin hydraulique double effet.

 Der hydraulische Hubmast ECO 1603 eignet sich für kleine Traktoren und besteht aus U-Profilen aus Stahlpressteilen mit direktem Kontakt, einer zentralen Kette und einem doppelwirkenden Hebezylinder.

 Elevador hidráulico ECO 1603 indicado para tractores pequeños, fabricado con perfiles de acero prensado en forma de «U» en contacto directo, una cadena central y un cilindro de elevación de doble efecto.

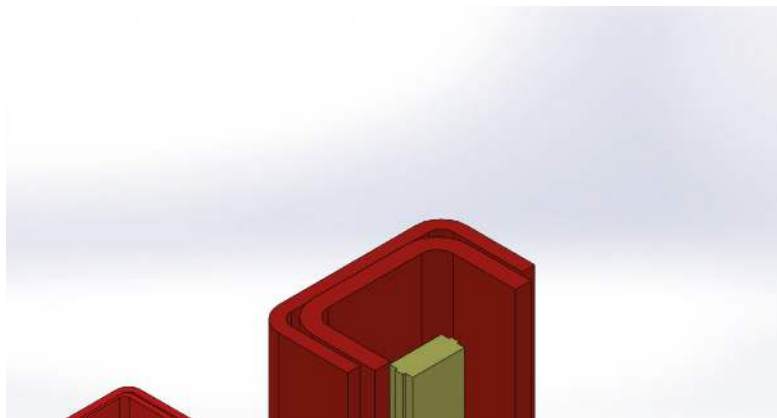

 Elevatore idraulico ECO costruito con profili in acciaio stampato a "U" a contatto diretto, un cilindro di sollevamento a doppio effetto e due catene.

 ECO hydraulic forklift built with U-shaped steel profiles in direct contact, featuring a double-acting lifting cylinder and two chains.

 Elévateur hydraulique ECO, construit avec des profilés en acier estampé en "U" à contact direct, un vérin hydraulique double effet et deux chaînes.

 Der hydraulische Hubmast ECO besteht aus U-Profilen aus Stahlpressteilen mit direktem Kontakt, einem doppelwirkenden Hebezyylinder und zwei Ketten.

 Elevador hidráulico ECO fabricado con perfiles de acero prensado en forma de «U» en contacto directo, un cilindro de elevación de doble efecto y dos cadenas.

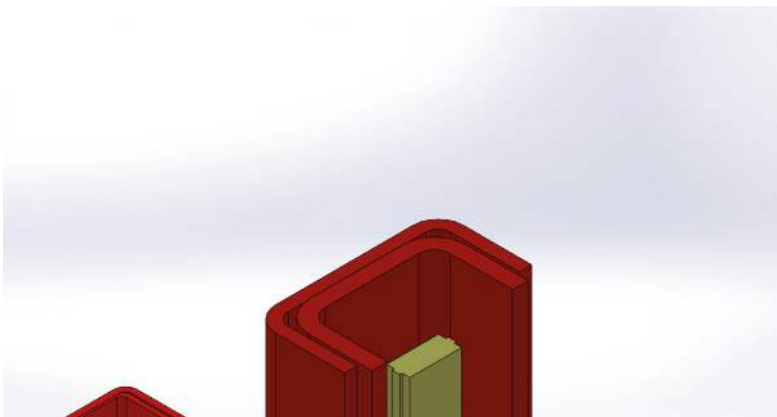

ECO 800

**ELEVATORI**



 Elevatore idraulico ECO costruito con profili in acciaio stampato a "U" a contatto diretto, un cilindro di sollevamento a doppio effetto e due catene.

 ECO hydraulic forklift built with U-shaped steel profiles in direct contact, featuring a double-acting lifting cylinder and two chains.

 Elévateur hydraulique ECO, construit avec des profilés en acier estampé en "U" à contact direct, un vérin hydraulique double effet et deux chaînes.

 Der hydraulische Hubmast ECO besteht aus U-Profilen aus Stahlpressteilen mit direktem Kontakt, einem doppelwirkenden Hebezyylinder und zwei Ketten.

 Elevador hidráulico ECO fabricado con perfiles de acero prensado en forma de «U» en contacto directo, un cilindro de elevación de doble efecto y dos cadenas.

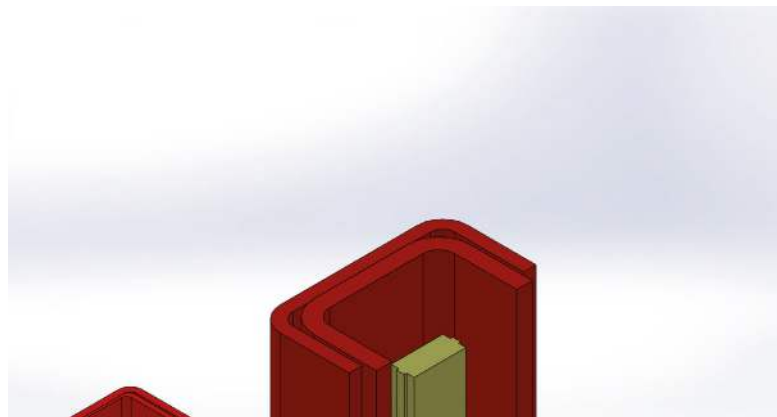

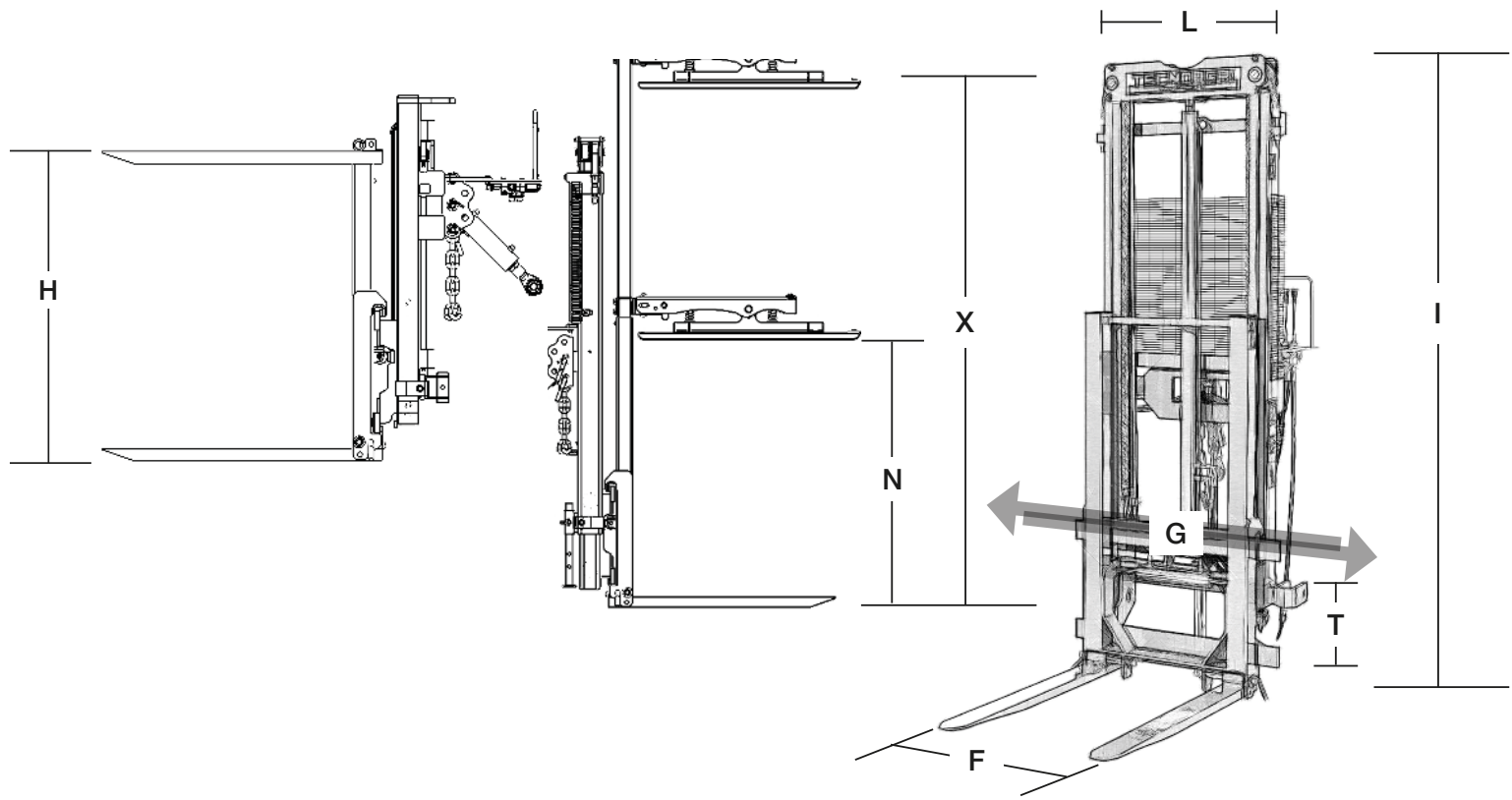



	H	I	N	X	L	T	F	G	
modello	mm	mm	mm	mm	mm	mm	mm	kg	mm
Eco1603	1600	1600	-	-	495	300	200÷755	300	☞ manuale
Eco2008	2000	1760	1060	1940	420	380	570÷710	800	100+100
Eco2208	2200	1860	1060	1940	420	380	570÷710	800	100+100
Eco1515	1500	1560	1060	1940	450	350	570÷710	1500	100+100
Eco1815	1800	1660	1060	1940	450	350	570÷710	1500	100+100
Eco2215	2200	1860	1060	1940	700	350	570÷710	1500	100+100
Eco2515	2500	2090	1330	2530	700	350	570÷710	1500	100+100
Eco3215	3200	2440	1330	2530	700	350	570÷710	1500	100+100
Eco3815	3800	2740	1330	2530	700	350	570÷710	1500	100+100
Super2515	2500	2010	1330	2530	730	330	570÷710	1500	100+100
Super3215	3200	2360	1330	2530	730	330	570÷710	1500	100+100
Super3220	3200	2360	1330	2530	695	375	570÷710	2000	100+100
Super3820	3800	2710	1330	2530	700	350	570÷710	2000	100+100
Super4020VT	4000	3030	1330	2530	700	350	570÷710	2000	100+100